

Lámparas a medida

—
Custom lighting

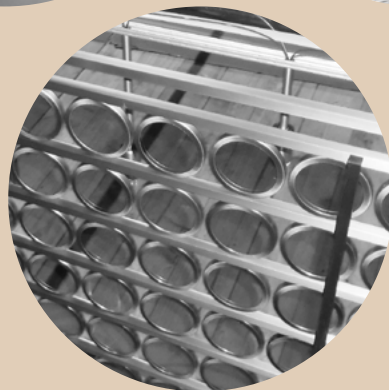

Pujol iluminación

“De la
idea a la
realidad”

—
*“From idea to
reality”*



PUJOL ILUMINACIÓN cuenta con más de 40 años de experiencia como fabricante de luminarias de diseño contemporáneo.

Fundada en 1978, ha conseguido ser referencia en el sector de la fabricación a medida, por el diseño y la calidad de sus acabados, y por la excelente relación con sus clientes y su clara vocación internacional.



PUJOL ILUMINACIÓN is a company with more than 40 years of experience as contemporary lighting manufacturer.

Founded in 1978, it has become one of the leading producers of custom lighting due not only to the design and quality of its products, but also because of its clear international vocation and its excellent relationship with the customers.



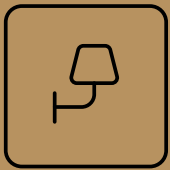
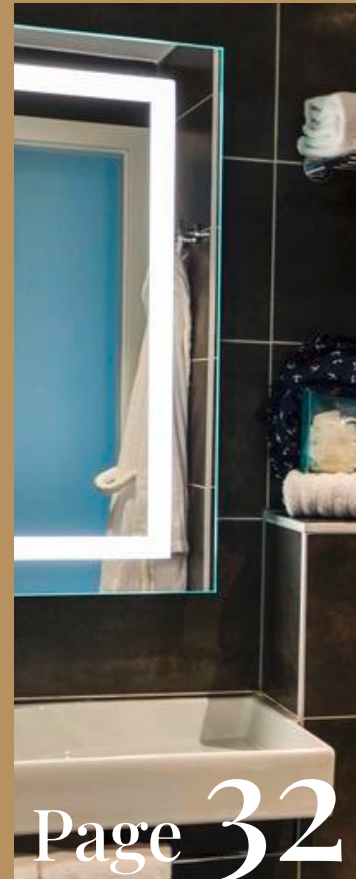

Apliques
-
*Wall
lights*



Apliques
cabecero
-
Bedside lights

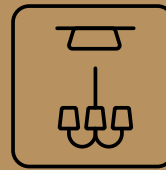

Colgantes y
Plafones
-
*Pendant &
Ceiling
lights*



Espejos
-
Mirrors



Page 36



Page 42



Page 48

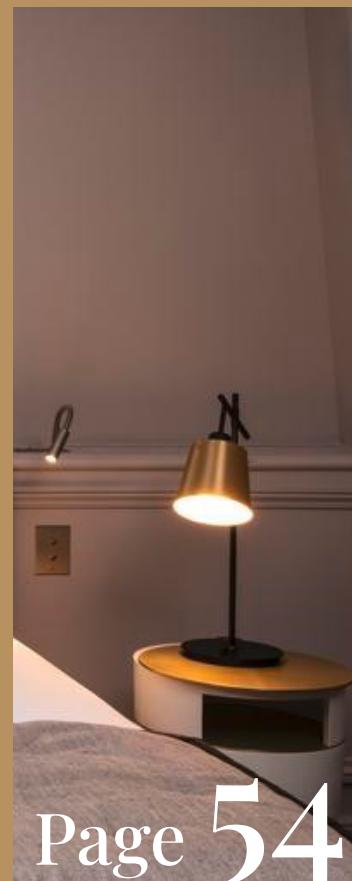

Page 54



Fibras
naturales
–
*Natural
fibers*

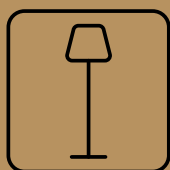

Pies
de salón
–
*Floor
lamps*



Señalética
–
Signage

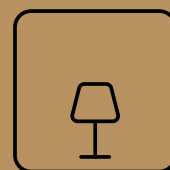













Sobremesas
–
*Table
lamps*

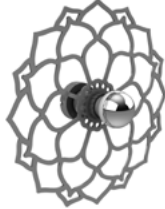

Apliques

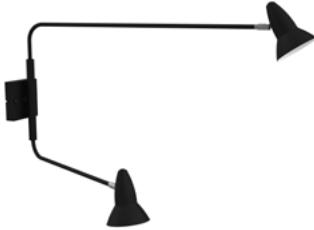
—

Wall lights

			
SP-272 8	SP-315 8	SP-741/B 12	SP-796 10
			
SP-744 12	SP-907 22	SP-592 9	SP-834 10
			
SP-839 11	SP-1183 12	SP-775 11	SP-768/B 13
			
SP-167/100 13	DIM-220 13	SP-1072 13	



SP-272



SP-315



SP-592

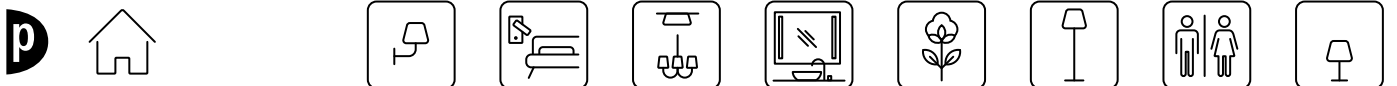

SP-796



SP-834

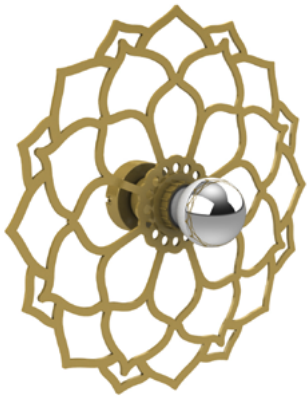

SP-839



SP-775

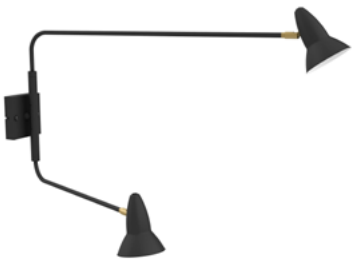

SP-1183

SP-907

SP-744

SP-741-B

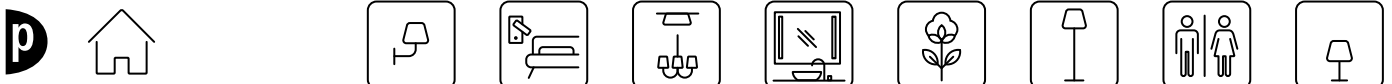

SP-768-B

SP-167-100

DIM-220

SP-1072

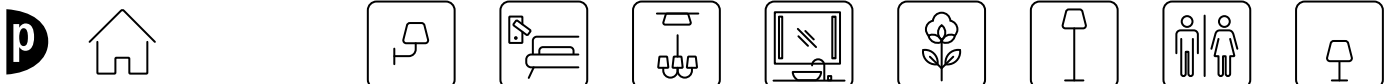

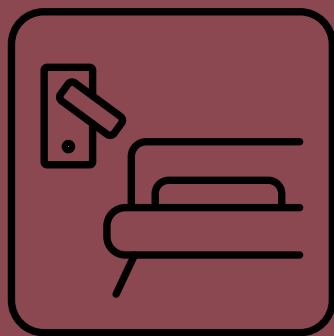







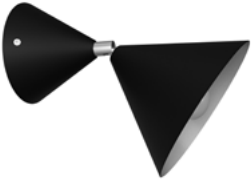

Apliques cabecero

—
*Bedside
lights*



 A-170 16	 SP-849-B 16	 SP-849-A-C 17	 SP-446 17
 SP-1170-B 18	 SP-950 19	 SP-1061-A 20	 SP-1049 21
 SP-1107 21	 SP-1060-A 21	 SP-1060-B 21	 SP-1108 21

A-170

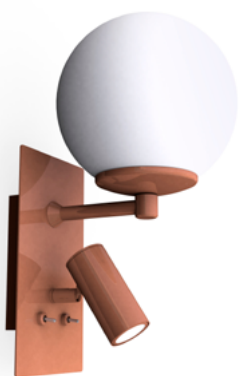
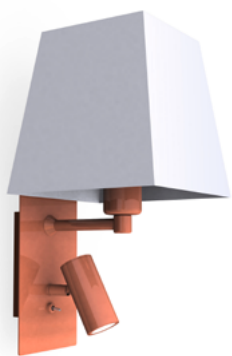

SP-849-B

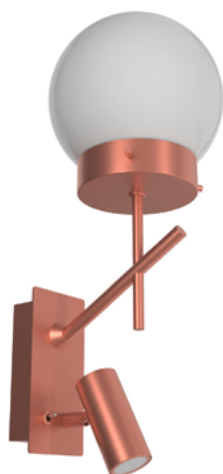

SP-849-A
SP-849-C

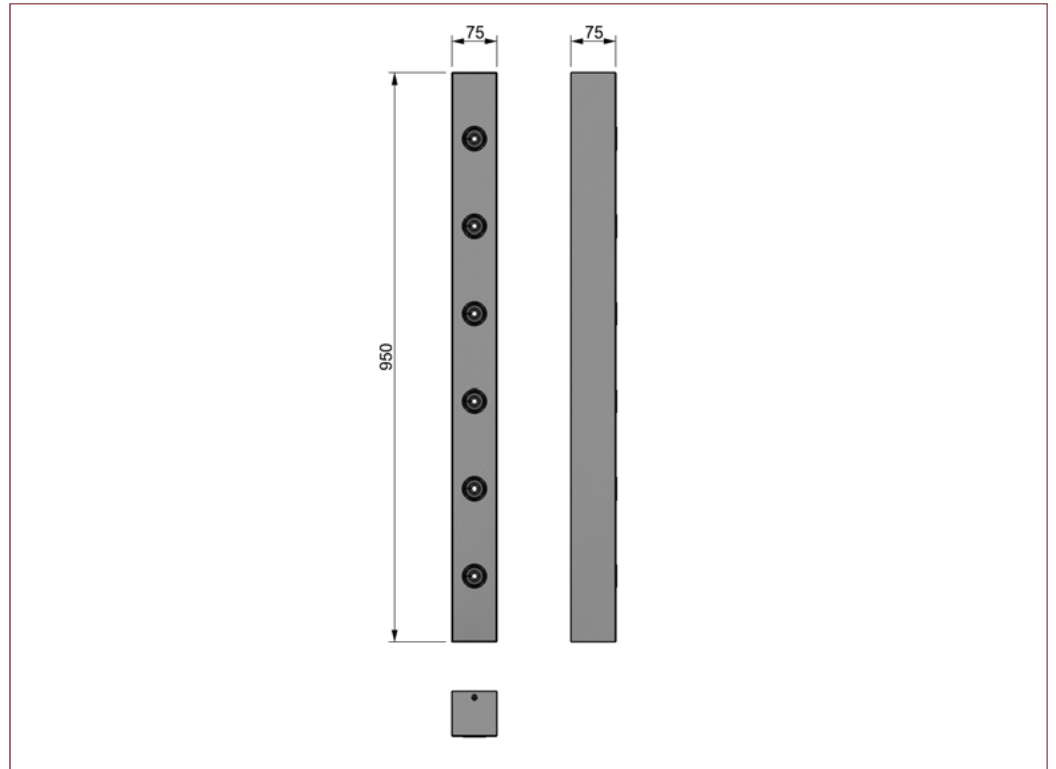

SP-446

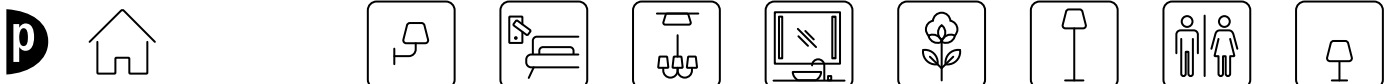

SP-1170-B

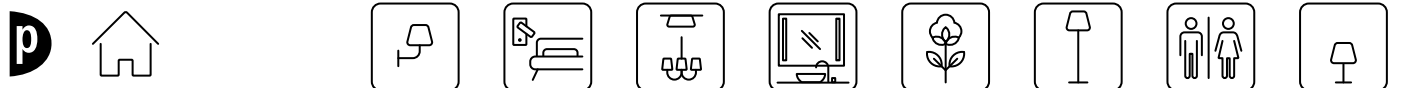

SP-950

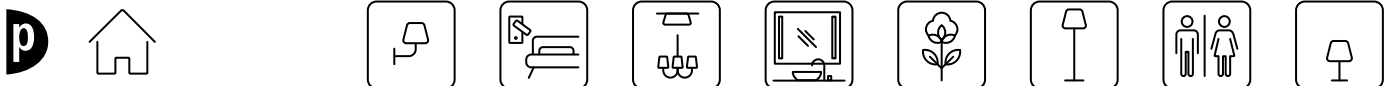
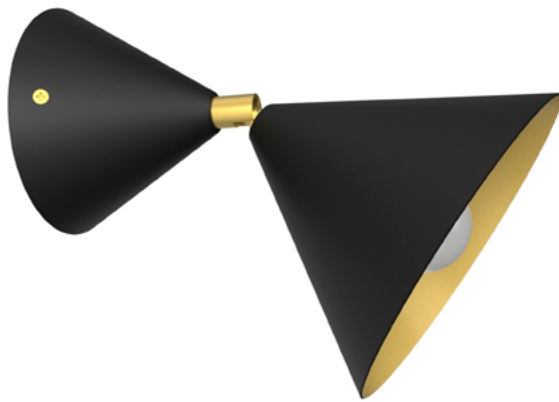

SP-1061-A

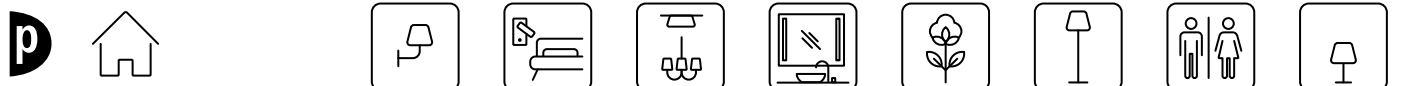
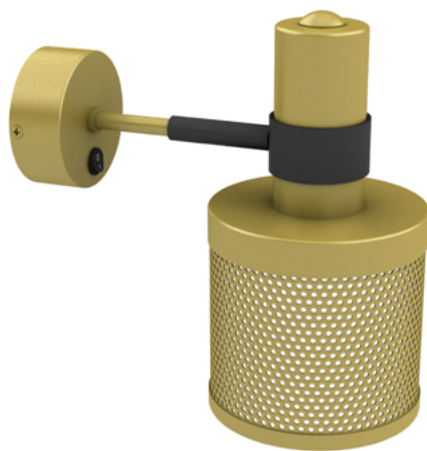

SP-1049

SP-1107

SP-1060-A

SP-1060-B



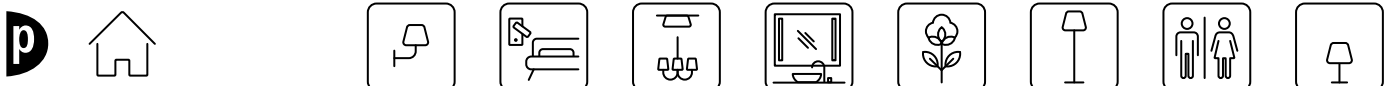

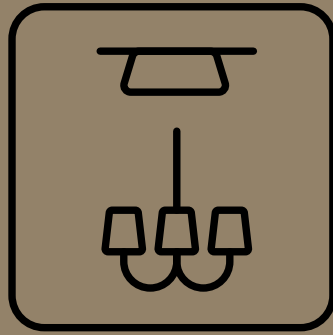

















SP-1108





Colgantes y Plafones

—
*Pendant &
Ceiling
lights*

 <p>C-159-22-30 24</p>	 <p>SP-768-C 30</p>	 <p>SP-792 25</p>	 <p>SP-823 27</p>
 <p>SP-861 26</p>	 <p>SP-870 27</p>	 <p>SP-946 26</p>	 <p>SP-1054 29</p>
 <p>SP-1061 28</p>	 <p>SP-1179 29</p>	 <p>SP-1180 24</p>	 <p>TUNA 30</p>
 <p>SP-265 31</p>	 <p>SP-335 31</p>	 <p>SP-573 31</p>	 <p>SP-574 31</p>
 <p>SP-596 31</p>	 <p>SP-658-G 31</p>	 <p>SP-663 31</p>	 <p>SP-676 31</p>
 <p>SP-865 31</p>	 <p>SP-923-A 31</p>		

C-159/20
C-159/30

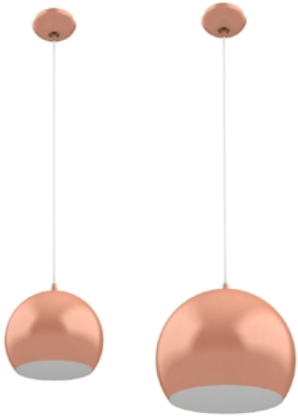

SP-1180



SP-792

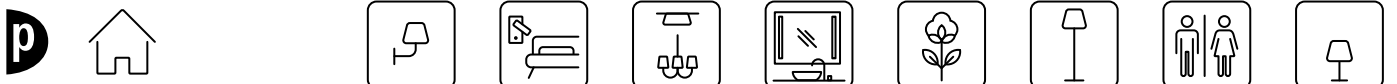
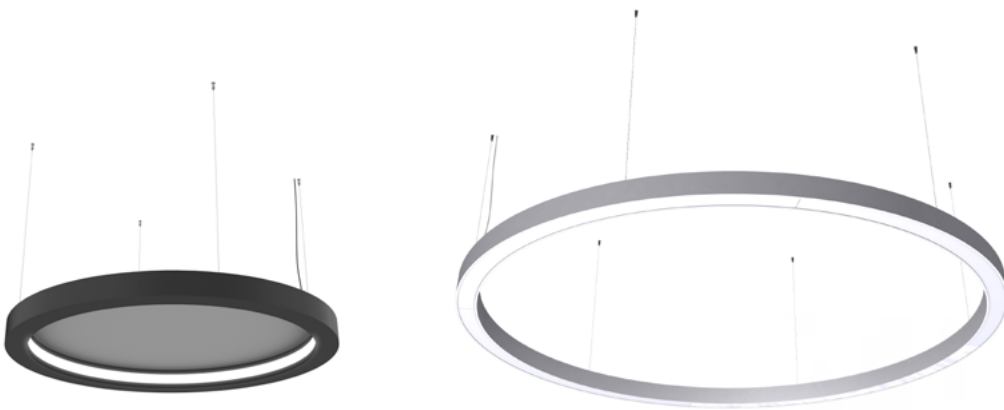

SP-861



SP-946



SP-870

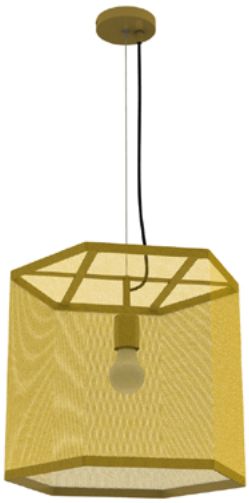

SP-823



SP-1061



SP-1179



SP-1054



SP-768-C



TUNA

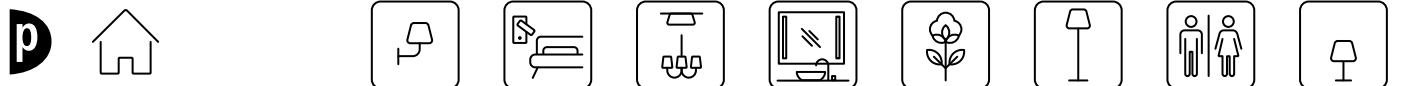

SP-265

SP-865

SP-335

SP-573

SP-658-G

SP-663

SP-676

SP-923-A

SP-574



SP-596





Espejos - *Mirrors*

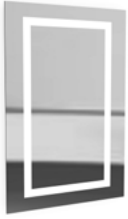

 SP-589-60-100 34	 SP-619 34	 SP-376 35	

SP-589-60
SP-589-110



SP-619



Medidas / Sizes ●



SP-376

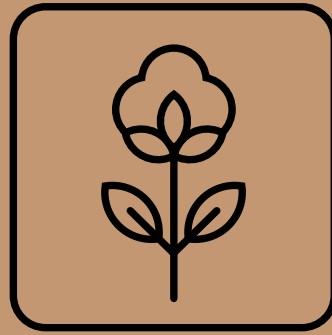

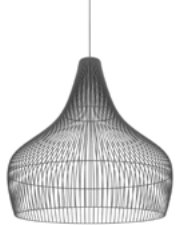

Fibras naturales

—
*Natural
fibers*

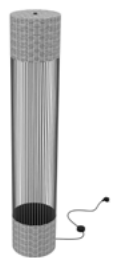
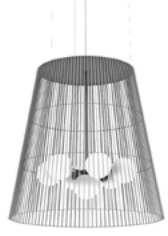
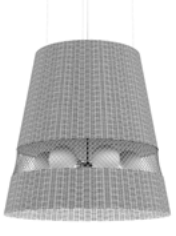
 MI-ES-01 38	 MI-ES-02J 40	 MI-ES-02M 40	 MI-ES-03 39
 MI-ES-04J 41	 MI-ES-04M 41		

MI-ES-01-80
MI-ES-01-120
MI-ES-01-150

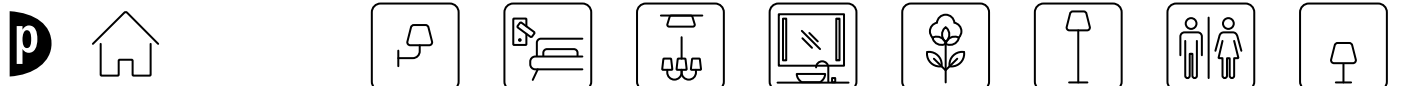

MI-ES-03

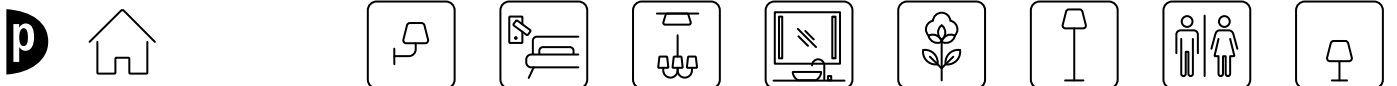
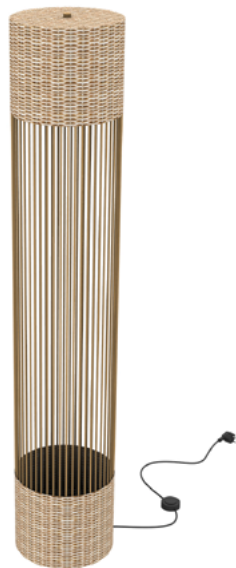

MI-ES-02-60J
MI-ES-02-80J
MI-ES-02-120J



MI-ES-02-60M
MI-ES-02-80M
MI-ES-02-120M



MI-ES-04J







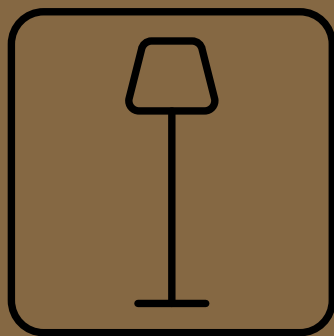



MI-ES-04M



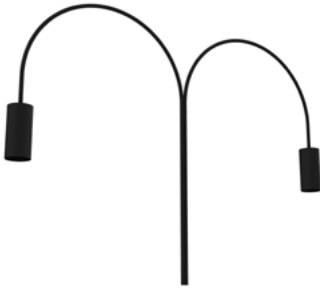

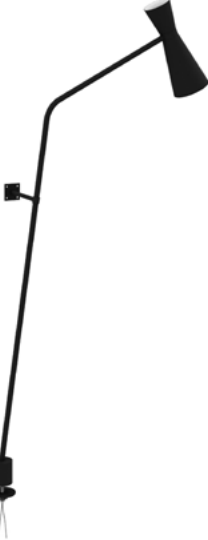
Pies de salón
—
Floor lamps

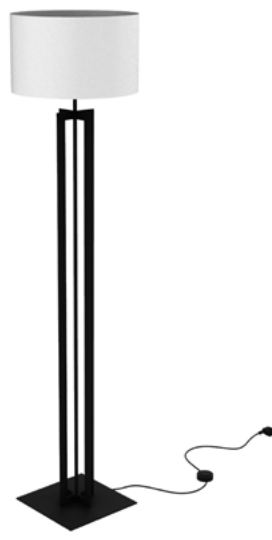
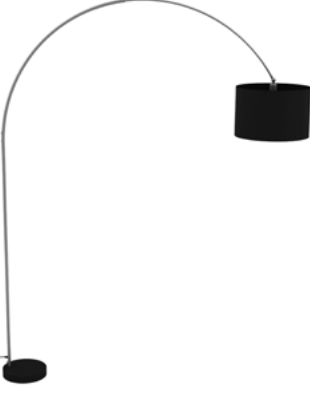

 <p>SP-808-P 44</p>	 <p>SP-488-1500 44</p>	 <p>SP-846 45</p>	 <p>SP-1008 45</p>
 <p>SP-1035 46</p>	 <p>SP-1038 46</p>	 <p>SP-302 47</p>	 <p>SP-877-P 47</p>
 <p>SP-1042-MJM 47</p>	 <p>SP-255 47</p>		

SP-808-P



SP-488-1500



SP-846

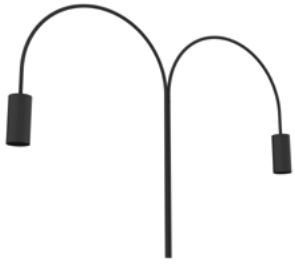

SP-1008



SP-1035



SP-1038

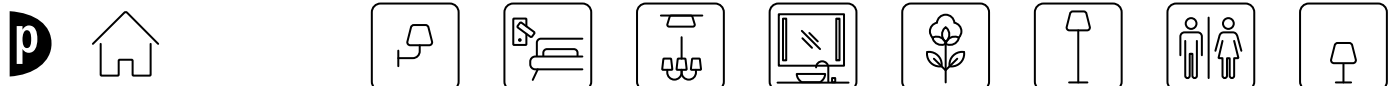

SP-302

SP-877-P

SP-1042-MJM

SP-255

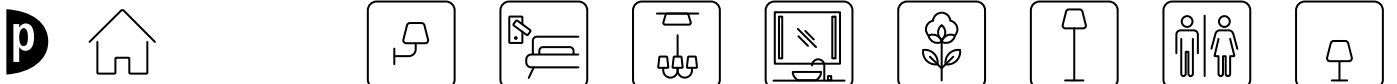









Señalética

—

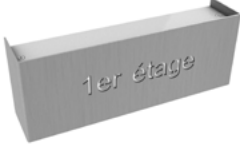
Signage

 A-205-1-E 50	 S-005 50	 SP-842 51	 SP-860 51
 SP-934 52	 SP-205/230 53	 SP-851 53	 SP-1012 53

A-205-1-E



S-005

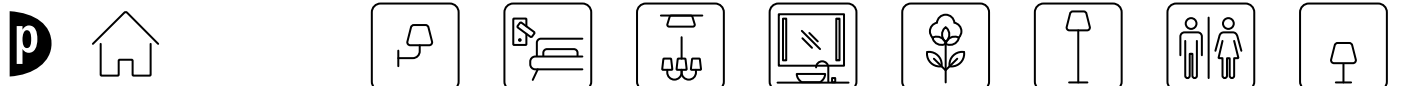

SP-842



SP-860

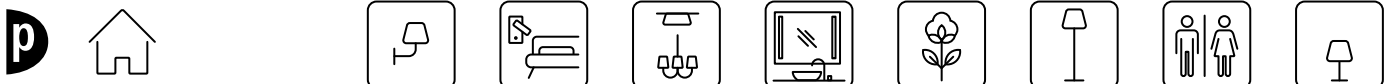

SP-934



SP-205-230

SP-851

SP-1012

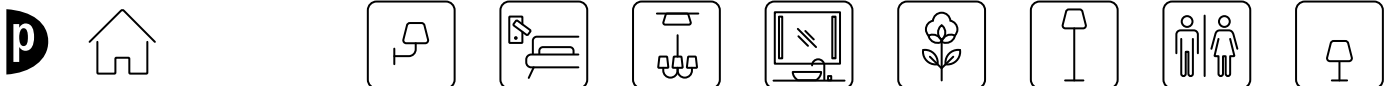

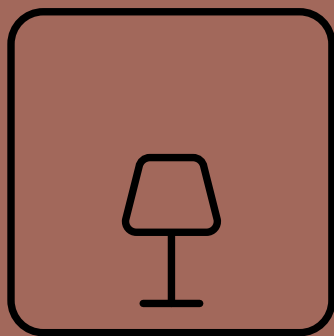

Sobremesas

—

Table lamps



 <p>SP-553-A-B 38</p>	 <p>SP-377 38</p>	 <p>SP-890 39</p>	 <p>SP-948 43</p>
 <p>SP-256 40</p>	 <p>SP-1162 43</p>	 <p>SP-1078 41</p>	 <p>SP-488 42</p>
 <p>SP-426 43</p>	 <p>SP-808-PS 40</p>	 <p>SP-1036 42</p>	 <p>SP-877-S 43</p>

SP-533-A
SP-533-B



SP-377



SP-890

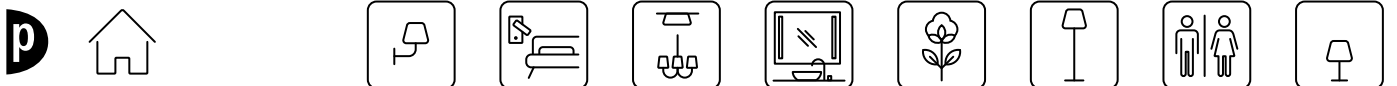

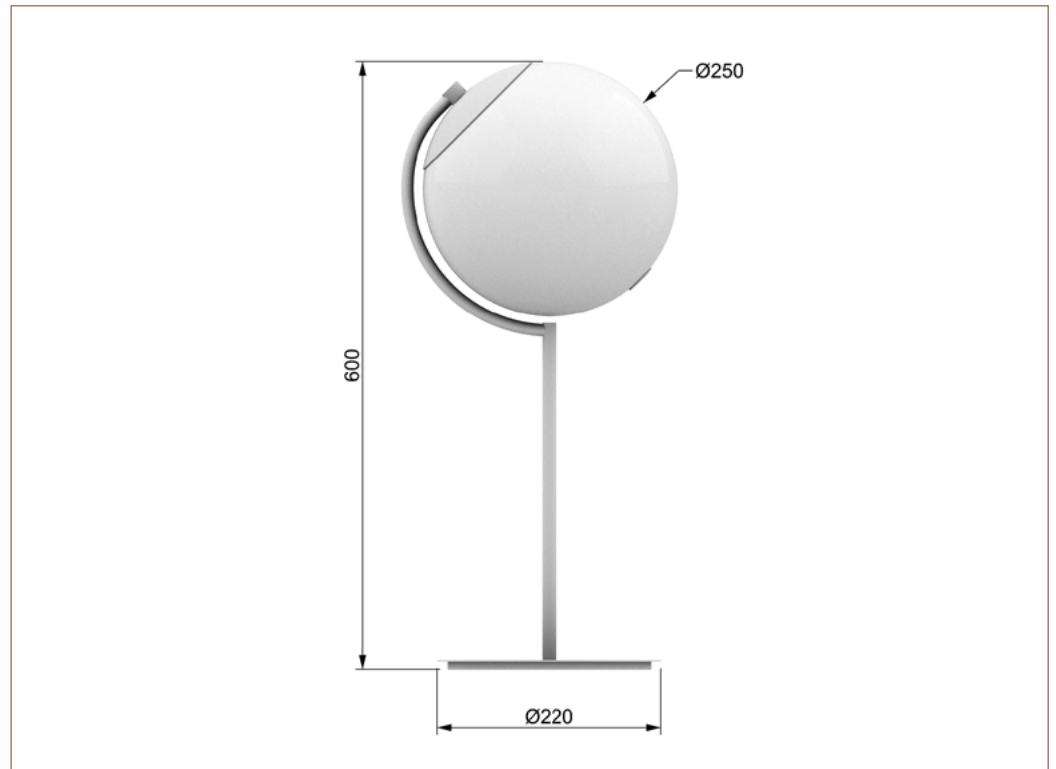
SP-256**SP-808-PS**

SP-1078

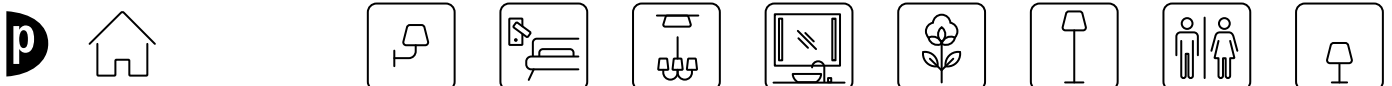

SP-488



SP-1036



SP-426

SP-877-S

SP-948

SP-1162



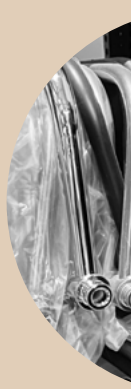
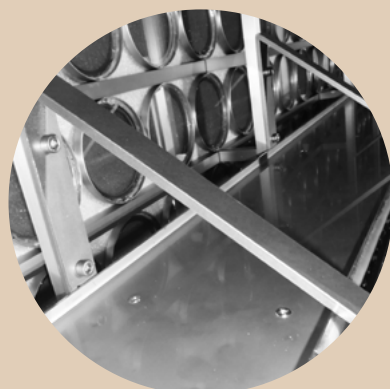
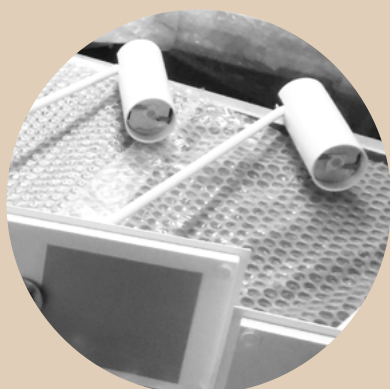

C/Industria 13
08980 Sant Feliu de Llobregat
Barcelona
SPAIN

www.pujoliluminacion.com